

SXPJ LED SERIES

LED Lighting for Hazardous and Hostile Locations

- Class I, Division 1, Group C & D
- Class II, Division 1, Groups E, F & G
- Class III
- Class I, Zone 1, Groups IIA & IIB
- Factory Sealed
- NEMA 4X, IP66
- UL 844, UL1598, UL1598A & UL8750
- CUL
- Tested to IESNA LM79 & LM80



AZZ | R-A-L™
RIG-A-LITE

SXPJ SERIES

LED Lighting for Hazardous and Hostile Locations

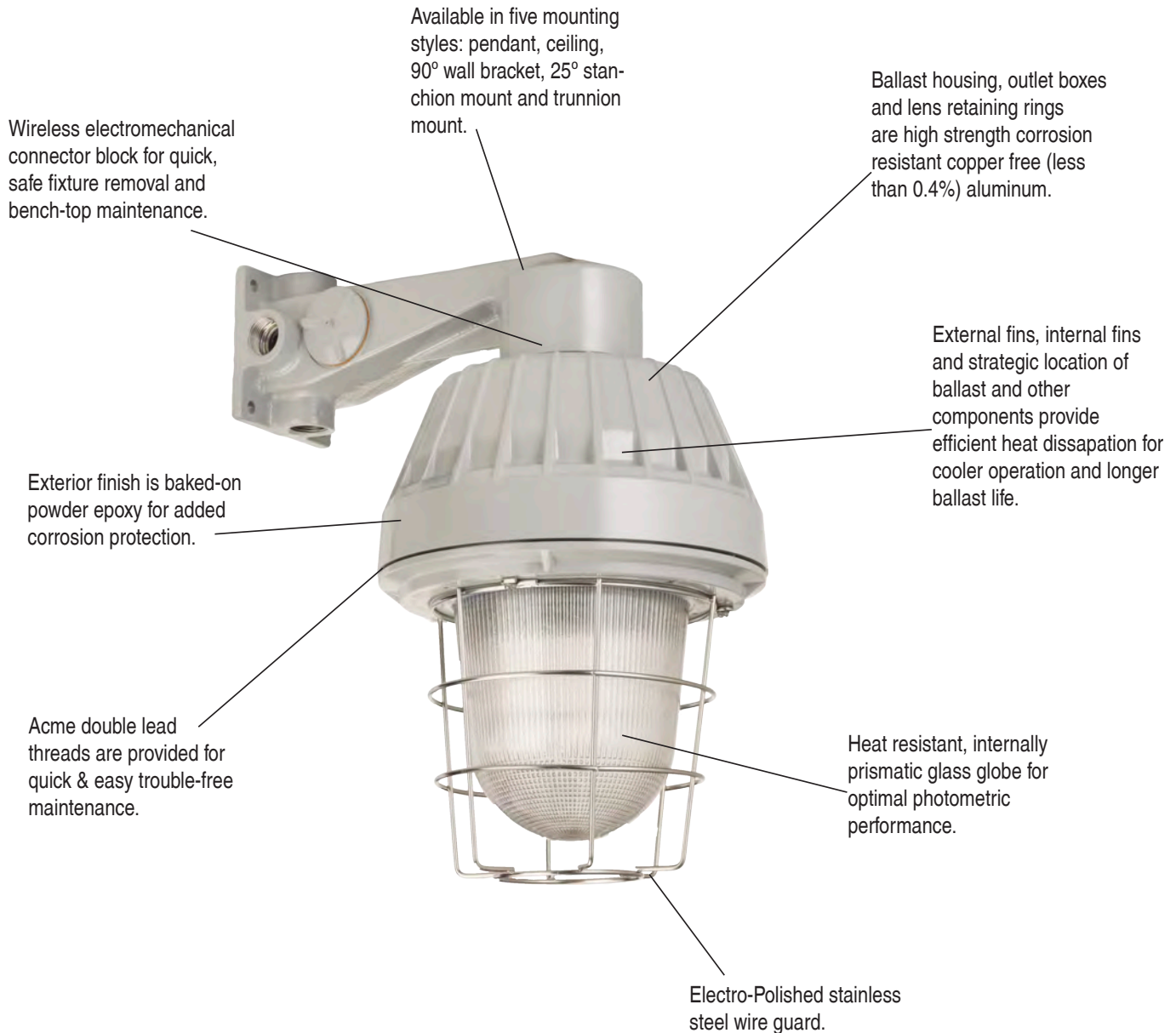

- Factory sealed—external seals not necessary
- Fiberglass reinforced polymeric reflectors are available as a standard option
- Aluminum reflectors are available as a deep-dome option

LED SXPJ Series

Explosion Proof • UL 844, 1598A & 8750 • Marine Outside Type • Factory Sealed

* Trunnion mount fixtures are not suitable for Class II environments

Catalog logic is for explaining catalog number structure only. Not all combinations are possible; consult factory for catalog numbers not listed in charts.

Catalog Number Logic

SXPJ 10-L-U-GG-P-XX

①

②

③

④

⑤

⑥

⑦

① BASIC SERIES

SXPJ LED Series
 Class I, Division 1, Groups C & D
 Class II, Division 1, Groups E, F & G*
 Class III
 Class I, Zone 1, Groups IIA & IIB
 Factory Sealed
 UL1598, UL1598A, UL8750 & UL844
 CUL
 NEMA Type 4X, IP66
 LED fixtures tested to IESNA LM79 &
 LM80 standards

② LAMP CURRENT/LAMP WATTAGE

10 = 98 Watt

③ LAMP TYPE

L = LED

④ BALLAST VOLTAGE

U = 120 thru 277V 50/60HZ

⑤ GLOBE & GUARD

GG = Globe and Guard
 G = Globe only

⑥ MOUNTING STYLE

P = 3/4" Pendant Mount
 P1 = 1" Pendant Mount
 C = 3/4" Ceiling Mount
 C1 = 1" Ceiling Mount
 W = 3/4" Wall Mount
 W1 = 1" Wall Mount
 S = 1-1/4" Stanchion Mount
 S1 = 1-1/2" Stanchion Mount
 T = Trunnion Mount*

⑦ OPTIONS¹

FB1 = Single Fuse Block ^{2 3}
 FB2 = Double Fuse Block ^{2 3}
 SC = Safety Cable (Eye Bolt Included)
 EB = Eye Bolt Only

¹ Consult factory for pricing.

² Not available with universal driver unless incoming voltage is specified. When installed, one fuse block is provided for 120 & 277V and two fuse blocks are provided for 208 & 240V. Fuse not included.

³ Fuse option not available for marine listed fixtures.

Certification Guide

Catalog #	Lamp		Rated Ambient °C	Class I, Groups C & D, Class 1, Zone 1, Groups IIA, IIB, & IIC		Class II, Groups E, F & G Class III	Supply Wire Temperature Rating, Minimum °C
	Type	Watts		Mounts		Mounts	
				Pendant, Wall or Ceiling	Trunnion or Stanchion	Pendant, Wall, Ceiling or Stanchion only	
SXPJ10L	LED	98	40	85 (T6)	85 (T6)	85 (T6)	90
SXPJ10L	LED	98	55	85 (T6)	85 (T6)	---	90

LED
SXPJ Series

Explosion Proof • UL 844, 1598A & 8750 • Marine Outside Type • Factory Sealed

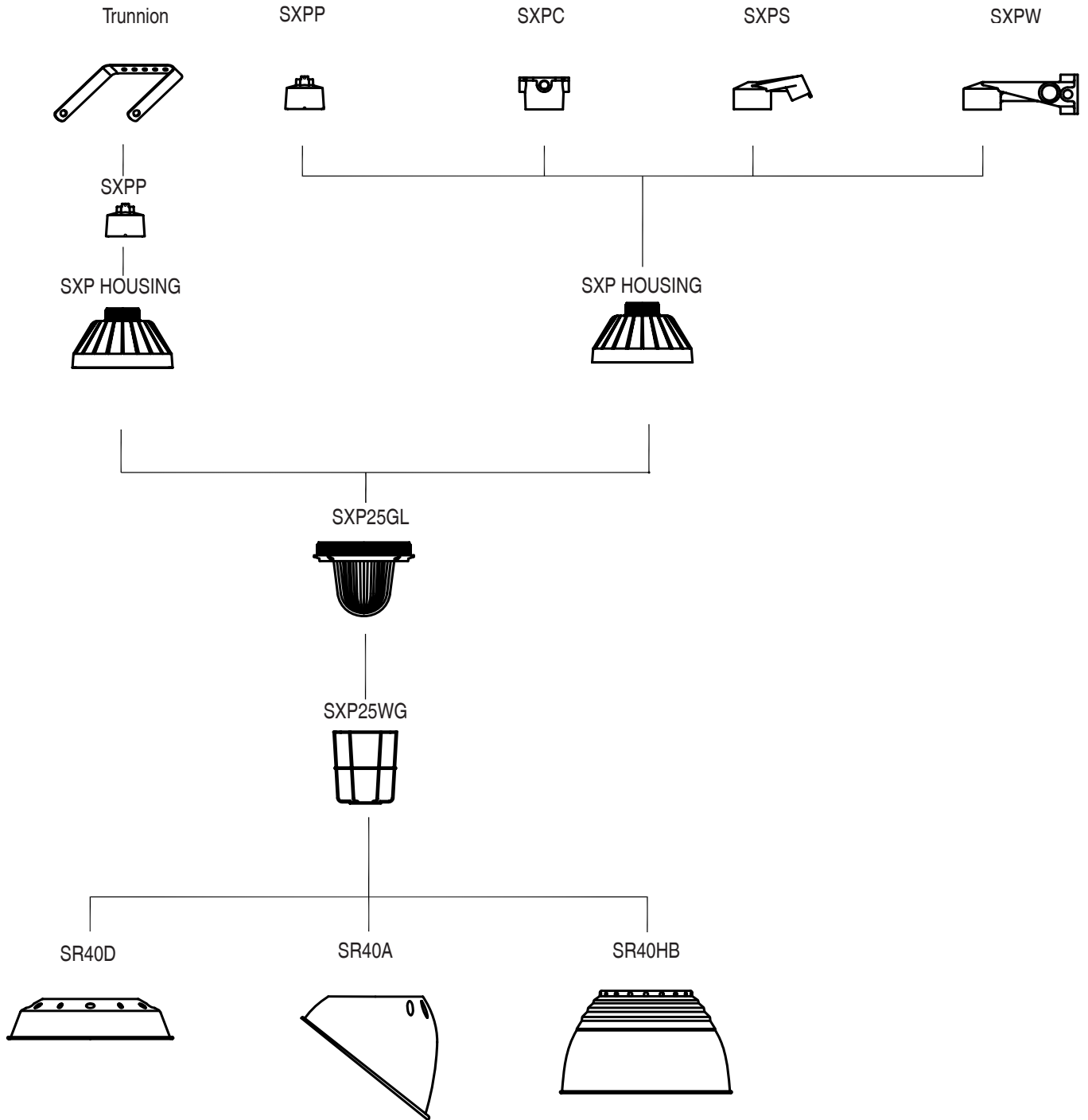

LED
SXPJ Series

Explosion Proof • UL 844, 1598A & 8750 • Marine Outside Type • Factory Sealed

Mounting Style	Lamp Watts	Conduit Size (In.)	120-277V 50/60HZ	Shipping Weight (Lbs.)
PENDANT 	98 98	3/4 1	SXPJ10-L-U-GG-P SXPJ10-L-U-GG-P1	41.6 41.6
CEILING 	98 98	3/4 1	SXPJ10-L-U-GG-C SXPJ10-L-U-GG-C1	43.5 43.5
WALL 	98 98	3/4 1	SXPJ10-L-U-GG-W SXPJ10-L-U-GG-W1	45.7 45.7
STANCHION★ 	98 98	1-1/4 1-1/2	SXPJ10-L-U-GG-S SXPJ10-L-U-GG-S1	42.7 42.7
TRUNNION★ 	98	3/4	SXPJ10-L-U-GG-T	43.6

★ Refer to Certification Guide to determine suitability of individual fixture.

LED SXPJ Series

Explosion Proof • UL 844, 1598A & 8750 • Marine Outside Type • Factory Sealed

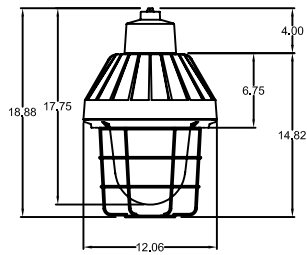

PENDANT MOUNT
SHIPPING WEIGHT: 40 LBS

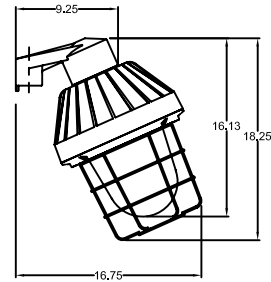

STANCHION MOUNT
SHIPPING WEIGHT: 41.2 LBS

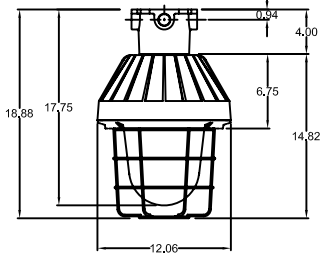
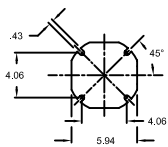

CEILING MOUNT
SHIPPING WEIGHT: 42 LBS

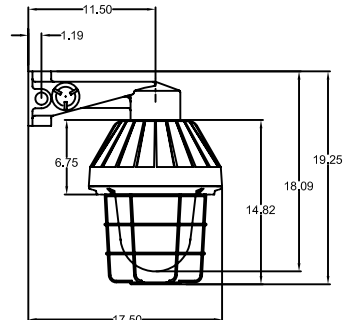
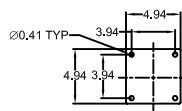

WALL MOUNT
SHIPPING WEIGHT: 44.2 LBS

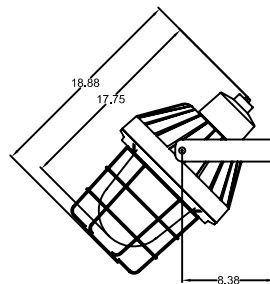

TRUNNION MOUNT
SHIPPING WEIGHT: 45.0 LBS

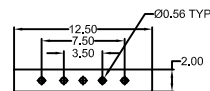

REFLECTORS

STANDARD DOME

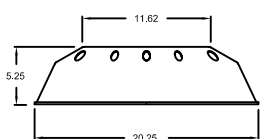

ANGLE

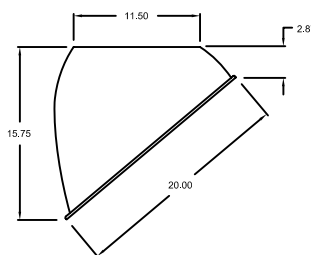

DEEP DOME

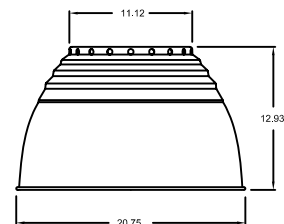

LED SXPJ Series

Explosion Proof • UL 844, 1598A & 8750 • Marine Outside Type • Factory Sealed

SXPJ10LUGGXX

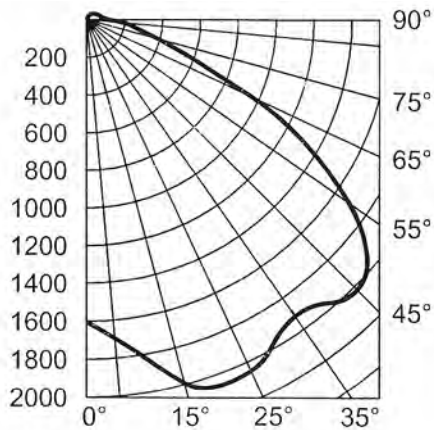

Total Lumens	7669
Input Power (watts)	98
Efficacy (Lumens/Watt)	78.1
CRI	67
CCT	5794





Candlepower



Deg	Parl.	22.5	45	67.5	Norm
0	1604	1604	1604	1604	1604
15	1659	1811	1879	1972	1991
25	1841	1921	2030	2037	2052
35	1675	1844	1803	1754	1831
45	1829	1846	1963	1916	2022
55	1471	1574	1568	1641	1693
65	855	875	871	889	959
75	339	366	372	374	390
85	170	178	179	188	200
90	102	106	108	109	115



LED SXPJ Series

Explosion Proof • UL 844, 1598A & 8750 • Marine Outside Type • Factory Sealed

Components and Accessories

Outlet Boxes	Description	Hub Size (In.)	Catalog Number	Shipping Weight (Lbs.)
	Pendant	3/4 1	SXPP SXPP1	2.15 2.15
	Ceiling	3/4 1	SXPC SXPC1	4.0 4.0
	Wall	3/4 1	SXPW SXPW1	6.20 6.20
	Stanchion	1-1/4 1-1/2	SXPS SXPS1	3.20 3.20

Globes And Guards	Description	Catalog Number	Shipping Weight (Lbs.)
	Prismatic Glass Globe Assembly for 70-150W HPS, 175-250W MH & LED	SXP25GL	6.50
	Stainless Steel Wire Guard for 70-150W HPS, 175-250W MH & LED	SXP25WG	1.50

Reflectors	Description	Catalog Number	Shipping Weight (Lbs.)
	Standard Dome Reflector Fiberglass Filled Polymeric	SR40D	3.00
	30° Angle Reflector Fiberglass Filled Polymeric	SR40A	4.50
	High Bay Aluminum Reflector with Baked on White Enamel	SR40HB	5.00